

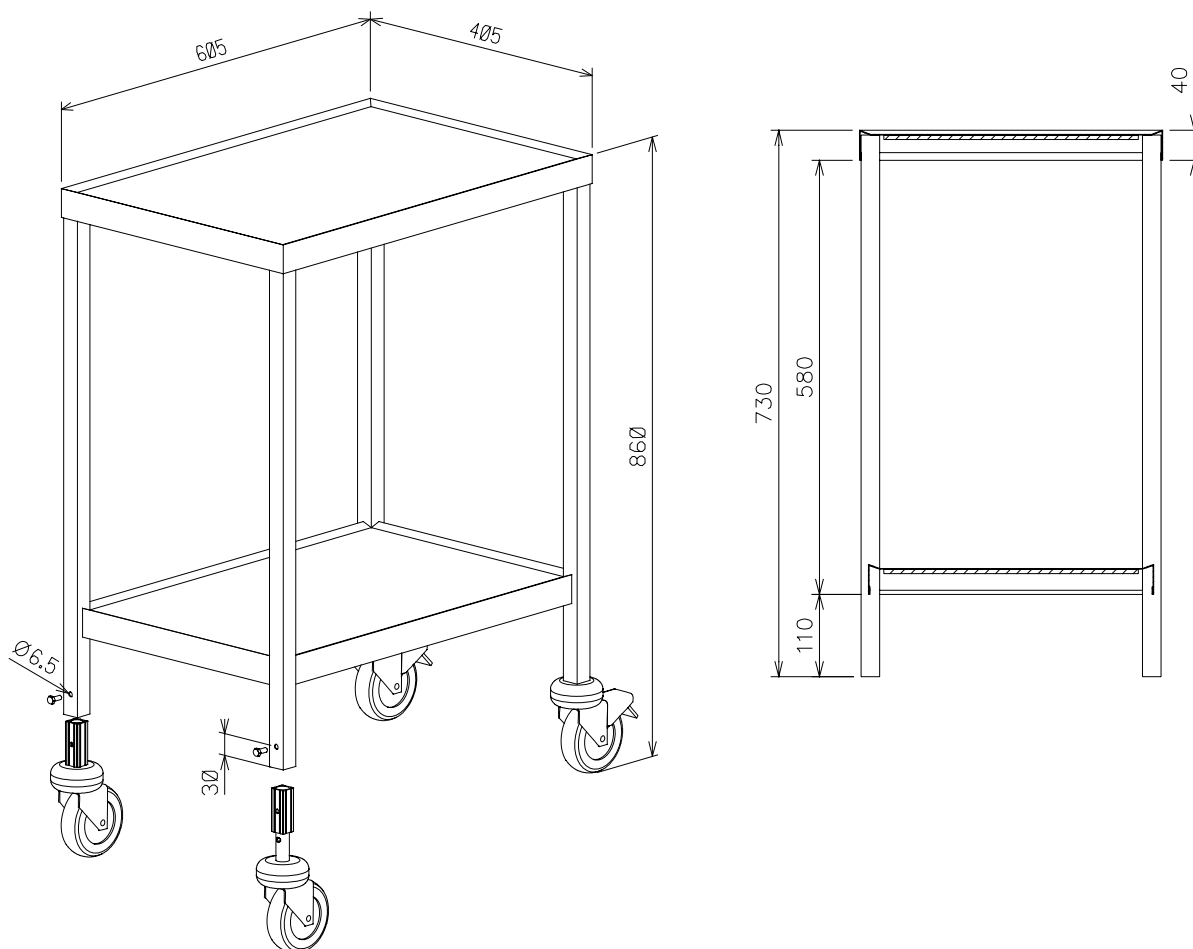

Technical drawing



Illustrative pictures



SPECIFICATION LIST

SELF CONTAINED	I.
Catalog number	
Width (x) [mm]	605
 Depth (y) [mm]	405
Height (z) [mm]	860
Number of inserts for trays	2
Lifting capacity [kg]	220
Wheels	Galvanized swivel castors Ø 100mm, 2 with brake
Material	Stainless Steel
Additional information	
Spare parts*	